

Step 1

PLEASE DONOT TIGHT ONE SCREW COMPLETELY, AFTER FASTEN ALL SCREWS THEN TIGHT THEM ALL.

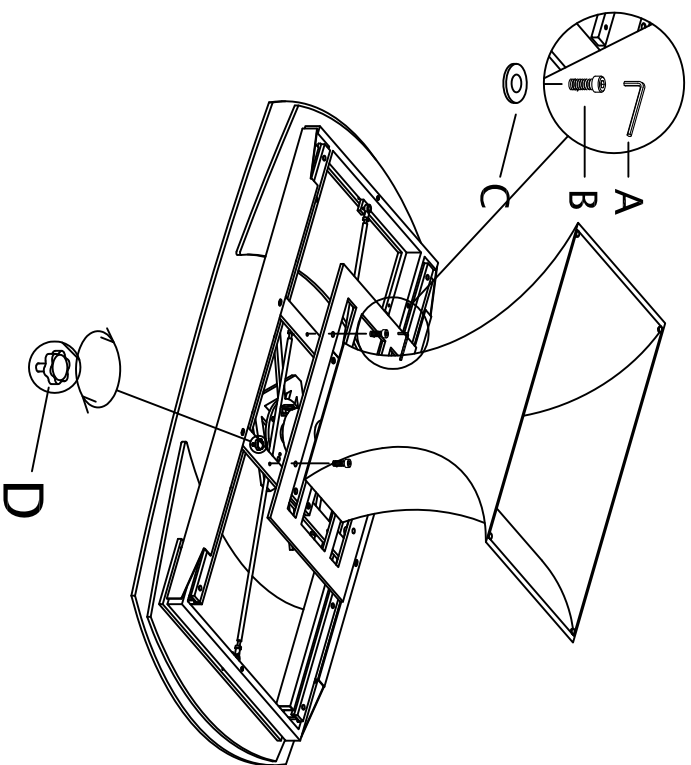

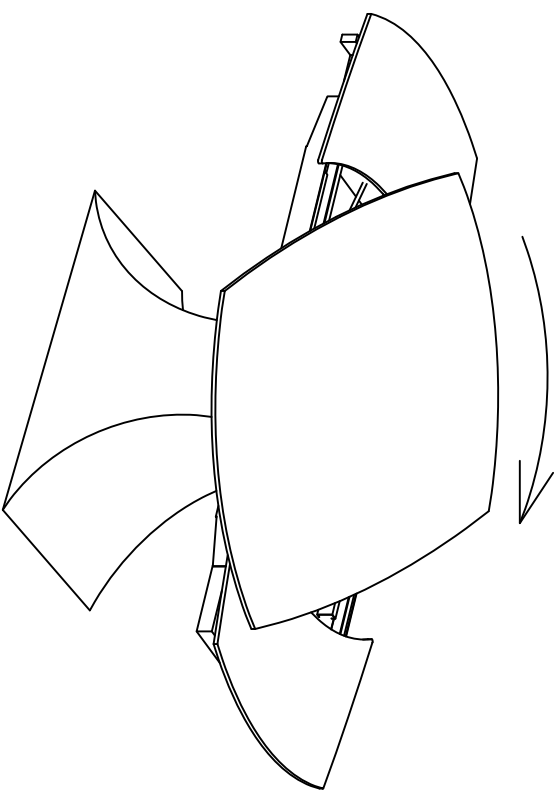



Step 2

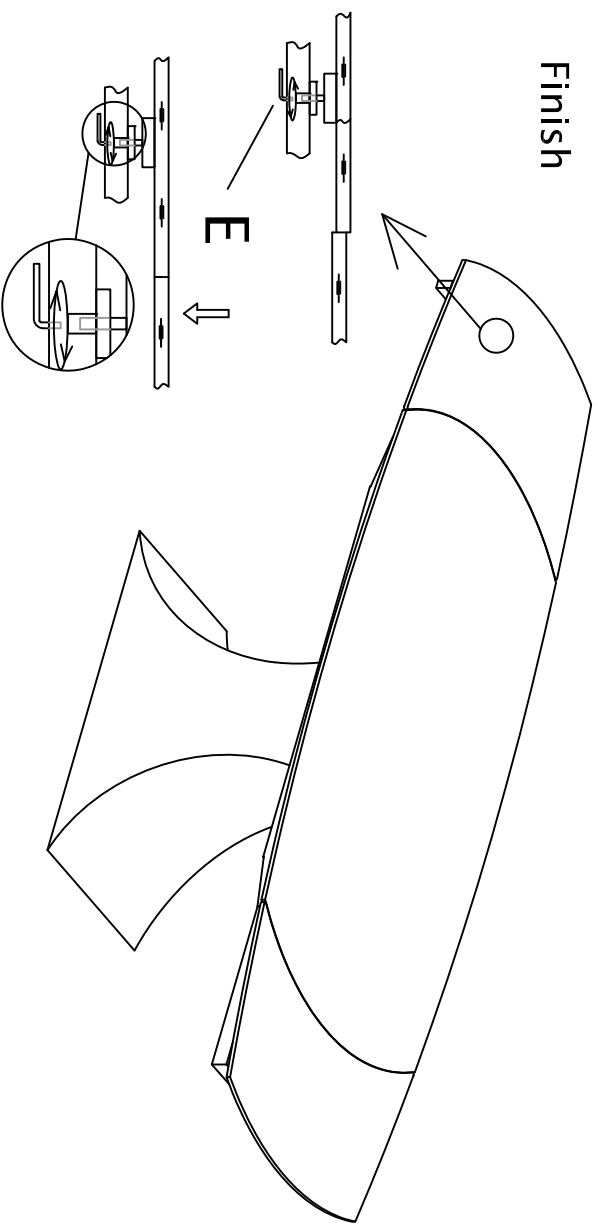

Finish



DT9035CI

NO.	A	B	C	D	E
TYPE	 5#	 M8x30	 $\Phi 17 \times \Phi 8 \times 1.5$		 4#
QTY	1 PC	4 PCS	4 PCS	2 PCS	1 PC